

From serial number: WBK 285390 H

Pos.	Qty.	Art. No.	Description	Pos.	Qty.	Art. No.	Description
1	1	9301-15	Support tube, front	25	1	9126-72	-Handgrip (pair)
2	1	9301-16	Support tube, rear	26	1	9100-180	-Lever M8
3	4	9328-51	Plastic cap, blue	27	1	9300-291	-Expander wedge
4	4	9328-26	Rubber foot	28	2	5675-9	Screw
5	1	9328-37	Transport wheel compl. (pair)	29	1	9394-71	Frame cover, left
6	4	5845	Locking nut M8	30	1	9384-45	Belt control
7	1	9300-55	Chain 1/2" x 1/8", 116 l	31	1	9374-41	Instrument cover
8	2	9300-12	Screw MVBF M8x16 mm	32	1	9374-9	Front frame
9	1	9300-220	Pedal, pair	33	1	9374-29	Weight holder
10	1	9300-207	Pedal strap, pair	34	1	5843-9	Nut M6
11	2	8523-2	Dust cover	35	1	9302-28	Plastic plug
12	2	8523-115	Screw M6S 8.8 M8 x 20 FZB	36	1	9300-3	Brake wheel, complete
13	1	9326-164	Magnet	37	1	9300-24	Wheel suspension compl. set
14	1	9300-430	Steel crank set, complete	38	1	9300-17	-Bush, 23 mm
15	1	8966-175	BB cartridge bearing, complete	39	1	9300-18	-Axle
	1	9300-133	Locking screw, complete set	40	3	91001-6	-Bearing 6001-2z
16	1	9300-122	-Locking knob	41	1	9106-14	-Connection
17	2	9300-134	-Pressure washer	42	1	9106-13	-Sprocket
18	1	9300-138	Saddle post	43	1	9000-12	-Chain adjuster (pair)
19	1	9300-123	Top cover	44	1	5683	Screw M5x75 mm
20	1	9300-115	Bushing for saddle post	45	10	9306-12	Plastic plug
21	1	4994-5	Saddle	46	2	5673-9	Screw M5x12 mm
	1	9300-114	-Saddle bracket	47	1	5681	Screw M5
22	1	8966-176	Support casing for BB-bracket	48	1	9374-70	Frame cover, right
23	1	9374-60	Bracket for frame	49	3	5671-19	Screw M5x20 mm
24	1	9300-280	Handlebar, complete				

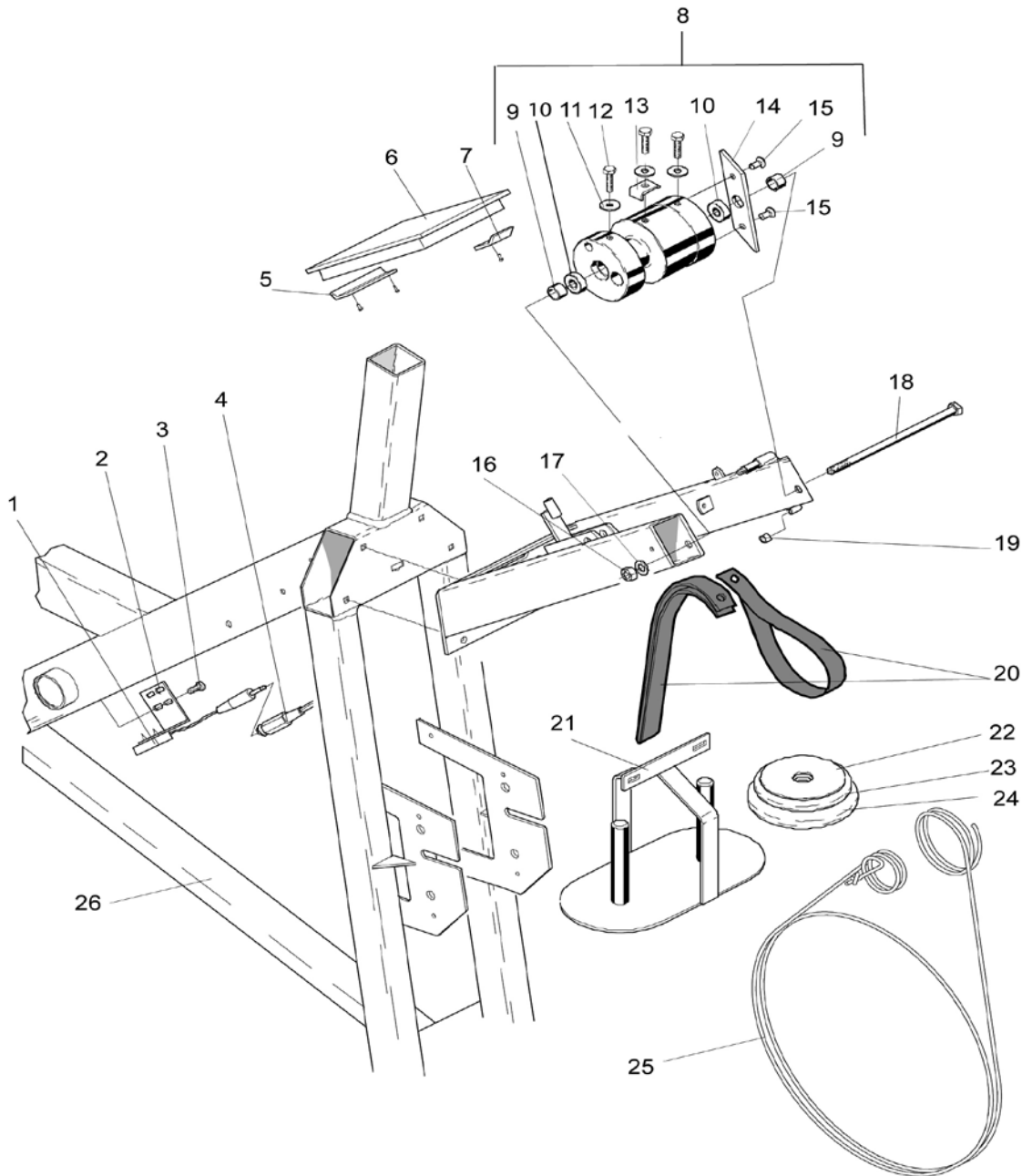

From serial number: WBK 285390 H

Pos.	Qty.	Art. No.	Description	Pos.	Qty.	Art. No.	Description
1	1	9326-162	Sensor		1	5878	-Washer
2	1	9326-166	Sensor holder	16	1	5844	Nut M8
3	2	9326-59	Screw	17	1	5864	Washer M8
4	1	9326-263	Cable	18	1	14374	Screw M8x160 mm
5	1	9374-172	Holder for meter 70x16 mm	19	1	9374-12	PVC cover
6	1	9374-170	Electronic meter	20	1	9324-26	Belt
7	1	9374-171	Holder for meter 16x16 mm	21	1	9324-25	Weight basket, 1 kg
8	1	9374-20	Tension device, complete	22	4	9102-30	Weight 0,1 kg
9	2	9127-37	-Spacer 8.5x12x13	23	1	9102-27	Weight 0,5 kg
10	2	19088-6	-Bearing 608-2z	24	4	9102-26	Weight 1 kg
11	2	5862	-Washer	25	1	9384-47	Brake belt, complete
12	3	14323-9	-Screw M6x16 mm	26	1	9301-5	Frame
13	1	9324-70	-Lock washer		1	9339-98	Chestbelt
14	1	9374-21	-Stop				
15	2	14379	-Screw M6x16 mm				